

New Classe 100

NOW THE STANDARD
IS CONNECTED



Classe 100

New range of video indoor units



 **Classe 100X16E**
THE CONNECTED SOLUTION



Classe 100V16E
SINGLE HOUSE APPLICATION



Classe 100V16B
MULTI-RESIDENTIAL HANDSFREE APPLICATION

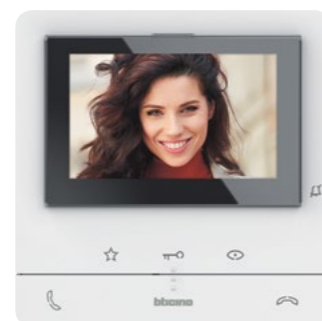

Classe 100V16M
MULTI-RESIDENTIAL HANDSET APPLICATION



New range of audio indoor units

Classe 100A16M
THE HANDSET SOLUTION



Classe 100A16E
THE HANDSFREE SOLUTION





Classe 100X16E

Eliot is the BTicino program dedicated to connected objects (Internet of things) which identifies all those products or systems which, because they can connect to the Cloud, give added value in terms of functionality, information, interactions with the environment and use.

Now the standard is connected

BTicino renews the range of **Classe 100** indoor units by introducing Wi-Fi connectivity in the standard video door entry system offer. The result is a range of video and audio indoor units with a modern and elegant design, capable of meeting all installation needs.



Built-in connectivity for constant connection within the home.

22
apt

Up to **22 apartments** without a dedicated power supply.

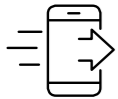

Immediate association with the **Door Entry CLASSE 100X App**.



Ideal for the refurbishment of old door entry systems.



No extra work for the installer; **easier to use** for the end user.



After being connected to **Classe 100X**, the smartphone becomes an "additional virtual video indoor unit" that can be used to answer calls, activate the opening of the door locks and activate the system cameras.

Maximum freedom. Always at ease, also when away from the home.

Thanks to the **built-in Wi-Fi connectivity**, Classe 100X gives the possibility of managing various functions quickly and safely using the smartphone.



Full screen, compact view.

The **5" display** always ensures great visibility, irrespective of the type of installation.

Thin and minimal.

Modern design combined with **small thickness, lightness and solidity**: this is the characteristic design of the new Classe 100.

Integration between physical and digital controls for better user experience.

New tilting control to answer and end the call, together with a range of touch controls for other functions.



App Functions



Answer the call comfortably from your home sofa

Absolute freedom of movement inside your home. You can answer the video door entry call from any room of your home.



Answer calls from anywhere in the world

Out of the house, on holiday or in the office. Answer the video door entry call wherever you are.



Open the gate

Returning home by car and cannot find your gate remote control? No problem, you can open the gate with your smartphone.

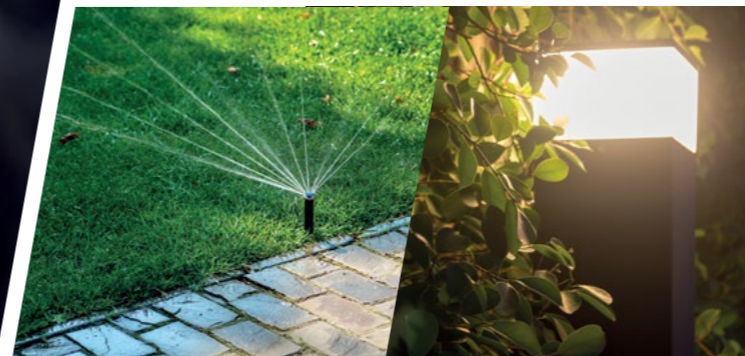

Switch on the lights or water the garden

Even when you are out or on holiday, you can comfortably activate the garden watering and switch the lights on directly from your smartphone.

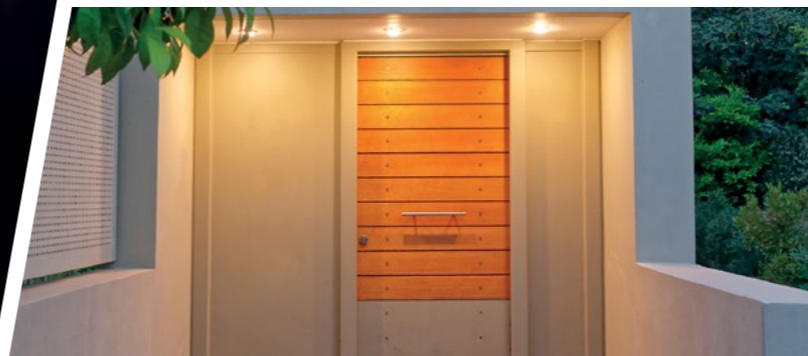

See what is happening outside the home

More security for your home. Using your smartphone you can activate the external and internal cameras connected to your video door entry system



Call home directly

Always keep in touch with anyone at home. The smartphone is an intercommunicating terminal with your video indoor unit.

Door Entry App Classe 100X

Conceived for easy daily use



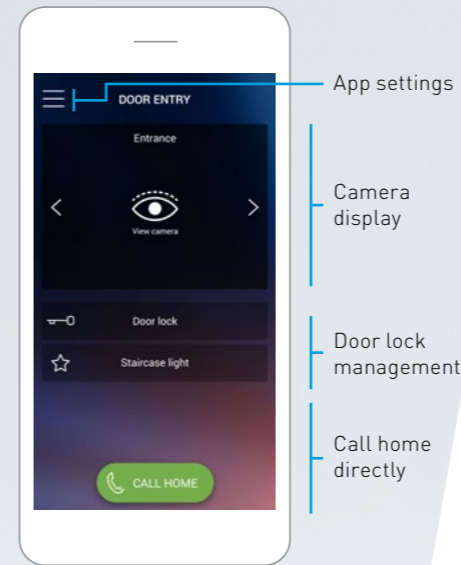

HOME PAGE
SCREEN

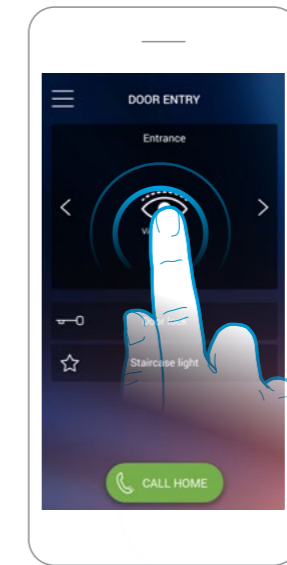

- App settings
- Camera display
- Door lock management
- Call home directly

CAMERA ACTIVATION
SCREEN





 Select the camera and press to activate it

A simple touch for the end user

DOOR ENTRY is the app which allows you to use your smartphone to manage the video indoor unit calls locally and/or remotely with a simple touch, such as:

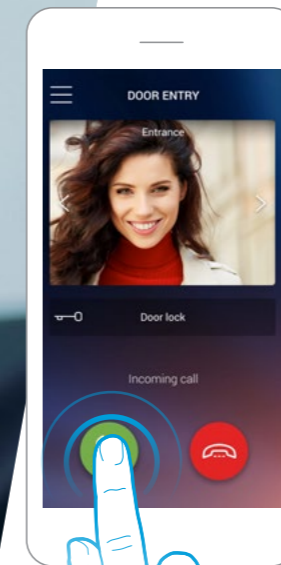
- Open the gate
- Activate cameras
- Switch on the timed lights in the garden



 Answering the indoor unit is as easy as answering a normal telephone call

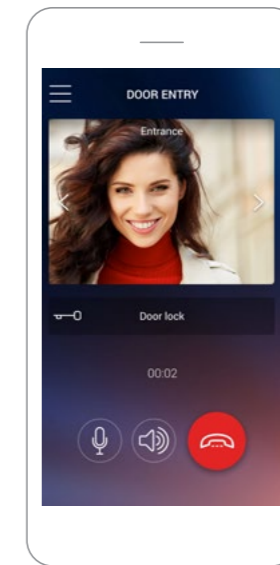

Call in progress

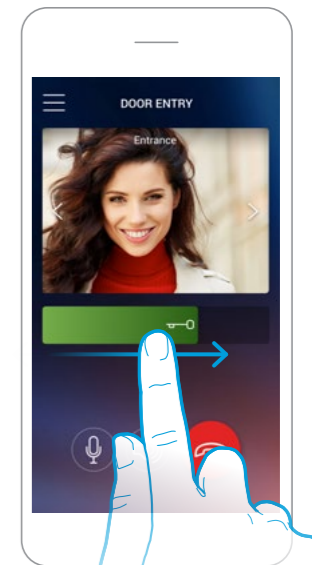

 To open the door, slide the key to the right – you will avoid opening the door accidentally

Immediately connected and configured



After installing the App, a **guided procedure allows the association** between smartphone and Classe 100X16E in few steps.

1.

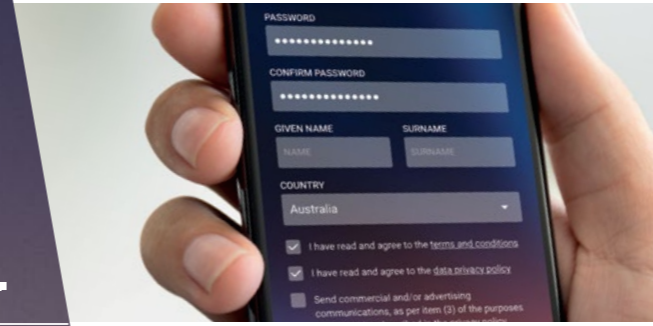

After the account has been created, go to the SETTINGS menu and select "CONFIGURATION".

2.



Using the smartphone, scan the QR Code that will appear on the video indoor unit screen.

3.

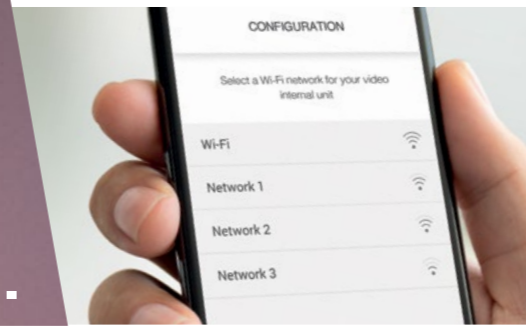

Select the home Wi-Fi network

4.

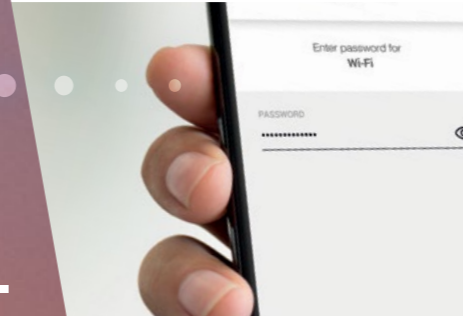

Once the password of the Wi-Fi network is entered, the App will search for the Classe 100 and will connect automatically and self configure.

The connection to the dedicated Cloud totally and safely automates the configuration on the home network (you do NOT need to configure your router). The video indoor unit transfers all the configuration of the 2 wires video door entry system (cameras, door locks, activations etc.) to the App. From Smartphone, using the App, you can always display the mobile devices associated to it and decide which to disconnect or cancel at any time.



Perfect for renovations

In existing 2 WIRES systems you can update and replace your old indoor unit or video indoor unit with CLASSE 100X16E. Thanks to the Wi-Fi connectivity you do not even need extra wiring.

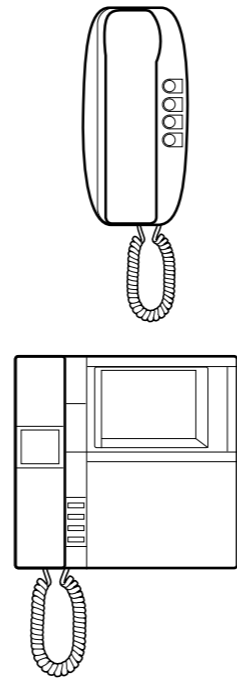

Classe 100X16E is the best solution available for renewing indoor unit

For the single house or for semi-detached houses applications



Built-in connectivity for constant connection within the home.

No extra work for the installer; **easier to use** for the end user.

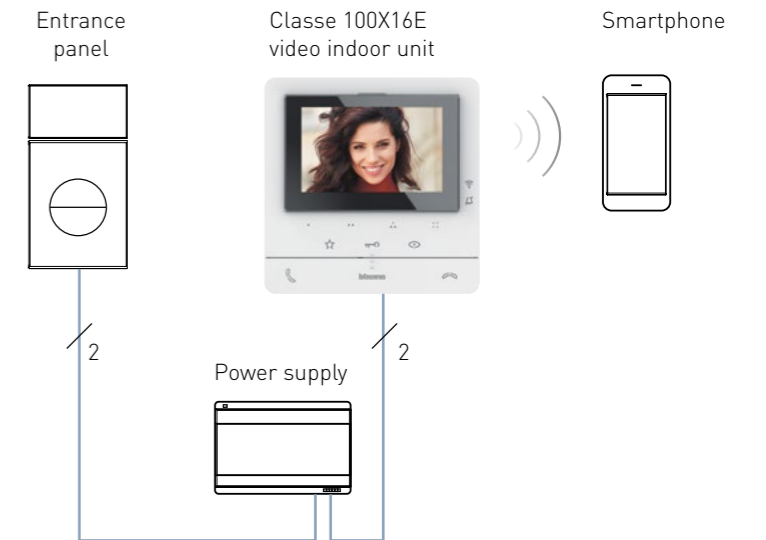

For apartment block or multi-residential applications



Built-in connectivity for constant connection within the home.

Up to **22 apartments** without dedicated power supply.

No extra work for the installer; **easier to use** for the end user.

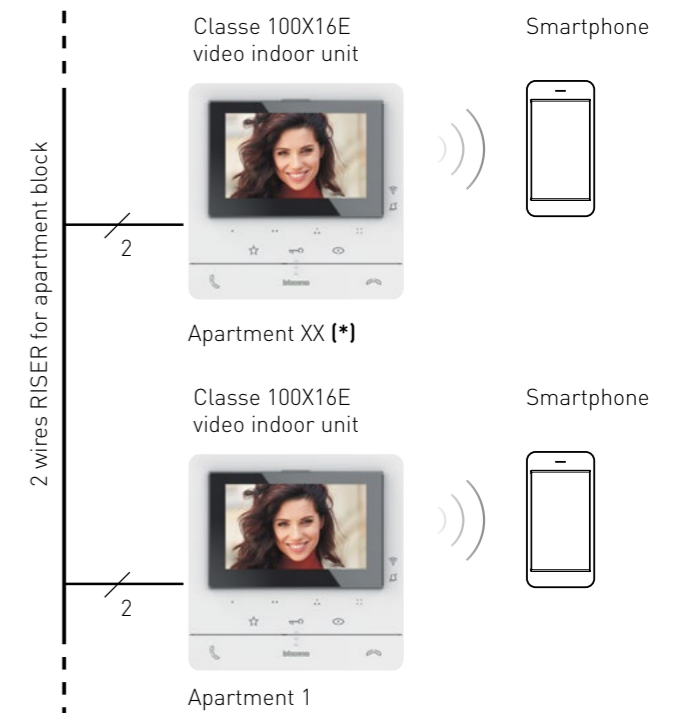

(*) NOTE: for the sizing of multi-family systems refer to the General Installation Standards of the 2 Wires System Technical Guide.

Replacing the old BTicino video indoor unit with the connected Classe 100 is simple and advantageous:

1 Remove the old 2 wires BTicino video indoor unit.



2 The new connected CLASSE 100 is installed **without the need for additional devices and/or wiring.** (Also in apartment complexes with up to 22 apartments).

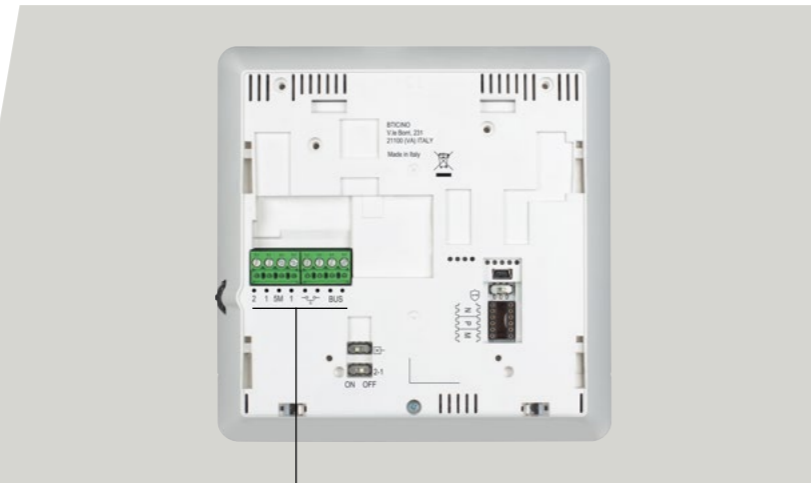

BTicino 2 wires video indoor units have standard plug-in SCS BUS clamps: **maximum simplicity.**

EXISTING INTERNAL DEVICES:

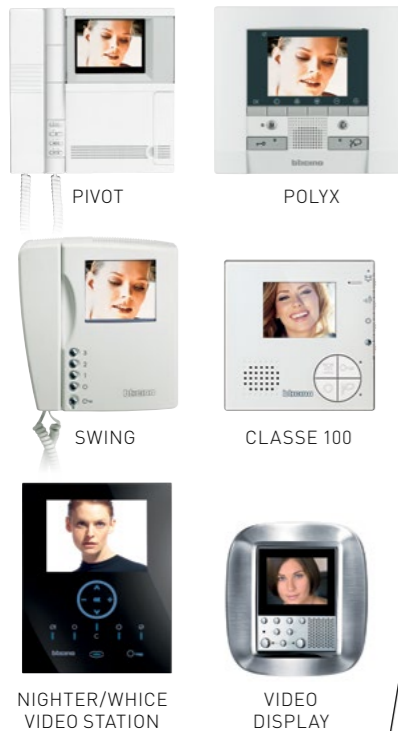

Aesthetic and functional upgrade

3 After installation, the new CONNECTED CLASSE 100 is associated to the Door Entry App, immediately making the **video door entry system functions** of your system available wherever you are **through your smartphone.**



No extra work for the installer; easier to use for the end user.



The new Classe 100 range

From connected video version to audio version:
The range available is very wide, **for everyone and for all needs.**

Classe 100
X16E



344682

The connected solution for all

Classe 100
V16E



344672

The perfect single house solution that ensures **maximum functional flexibility**

Classe 100
V16B



344652

The hands-free solution for **multi-dwelling buildings**

Classe 100
V16M



344625

The handset solution for **multi-dwelling buildings**

Classe 100
A16E



344282

The handsfree audio solution

Classe 100
A16M



344292

The **handset** audio solution



Wall-mounted installation

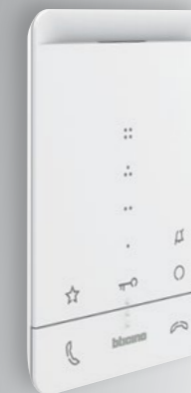

Wall-mounted installation



Tabletop installation



Tabletop installation

Wall mounted installation (with the bracket supplied) and tabletop installation with support **344692 (to be purchased separately):**

VIDEO HANDS-FREE INDOOR UNITS

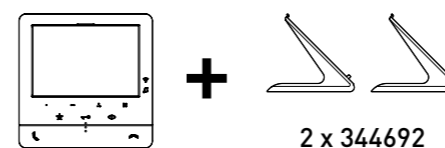



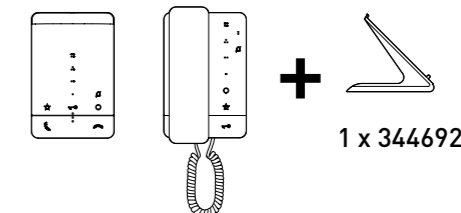

AUDIO INDOOR UNITS



CLASSE 100



Front view

Touch sensitive controls

-  Door lock activation
-  Entrance panel/camera scrolling activation
-  Staircase light activation
-  Customisable controls for the activation of accessory functions (e.g. intercom, activation of additional door lock, various activations)



LED notifications

-  Wi-Fi Connection
-  Ringtone exclusion

Physical control

Enable the handsfree communication

Tactile guide

Physical control

Disable the handsfree communication

Rear view

Plug-in connectors with screw clamps for connections

Adjustment and programming menu access and navigation joystick

Line termination ON/OFF micro-switch

ON / OFF micro switch to enable the additional power supply

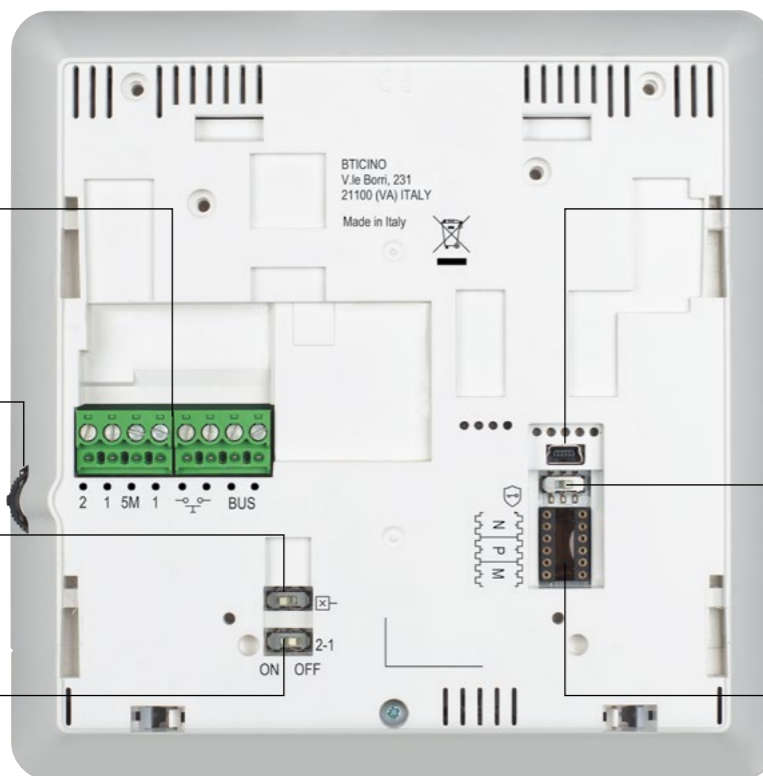

USB mini socket for firmware update

ON / OFF micro switch to enable the Safe Door Lock function

Configurator socket

Features and functions

	Classe 100 X16E	Classe 100 V16E	Classe 100 V16B	Classe 100 V16M	Classe 100 A16E	Classe 100 A16M
						
	344682	344672	344652	344625	344282	344292

FEATURES

	Classe 100 X16E	Classe 100 V16E	Classe 100 V16B	Classe 100 V16M	Classe 100 A16E	Classe 100 A16M
LCD colour display	5 inches	5 inches	5 inches	4.3 inches		
Handsfree	●	●	●		●	
Finish	white	white	white	white	white	white
Available in KIT	364614					
Installation	wall / table	wall / table	wall / table	wall	wall / table	wall / table

AVAILABLE FUNCTIONS FROM AUDIO / VIDEO INDOOR UNIT

	Classe 100 X16E	Classe 100 V16E	Classe 100 V16B	Classe 100 V16M	Classe 100 A16E	Classe 100 A16M
Door lock activation	●	●	●	●	●	●
Staircase light activation	●	●	●	●	●	●
EP / Scrolling activation	●	●	●	●	●	●
Intercom (1)	●	●	●	●	●	●
Inductive loop (2)	●	●				
Floor call	●	●	●	●	●	●
No. of configurable keys	4	4	1	1	4	4
No. of available ringtones	20	16	16	16	16	16
Professional Studio (Office)	●	●			●	●
Wi-Fi connectivity	●					

AVAILABLE FUNCTIONS FROM DOOR ENTRY APP

	Classe 100 X16E	Classe 100 V16E	Classe 100 V16B	Classe 100 V16M	Classe 100 A16E	Classe 100 A16M
Answer video door entry system calls	●					
Door lock activation	●					
Staircase light activation	●					
Intercom call from smartphone to video indoor unit	●					
EP / Scrolling activation	●					

1) Audio call, max. 3 minutes, between indoor units of the same apartment/different apartments
 2) Use by people wearing hearing aids fitted with T selector

CLASSE 100
Catalogue



344682



Door Entry
CLASSE 100X App



344672



344652



344625

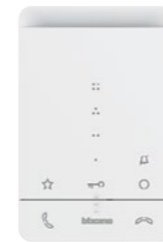

344282



344292



344692



346020

Item 344682 **CLASSE 100X16E CONNECTED VIDEO INDOOR UNIT**
 2 WIRES/Wi-Fi handsfree connected video indoor unit with inductive loop and 5" colour LCD display. It has 2 physical keys for the control of the main video door entry functions – answer and end a call – it has 3 touch keys for the control of the main functions – door lock release, staircase light control and entrance panel activation/scrolling – there are a further 4 configurable touch keys that perform different functions – e.g. intercom, additional door lock activation and generic activations. The device has a side lever to adjust: colour, brightness and display contrast, audio volume, call tone volume and Wi-Fi configuration. There are call exclusion notification LEDs and Wi-Fi. Also, thanks to the Wi-Fi connection, you can associate the video indoor unit to the Door Entry App (available for Android and iOS). You can manage the main video indoor unit functions (receiving calls, opening the door lock, activating the entrance panel/scrolling, firmware updating and additional activations) from the App. The installation can be made to the wall using the bracket (supplied) or using table support accessories (2 x 344692) – to be purchased separately. The device also has Professional Studio (Office) function and must be configured.

Item 344672 **CLASSE 100V16E VIDEO INDOOR UNIT**
 2 WIRES handsfree video indoor unit, with inductive loop and 5" colour LCD display. It has 2 physical keys for the control of the main video door entry functions – answer and end a call – it has 3 touch keys for the control of the main functions – door lock release, staircase light control and entrance panel activation/scrolling – there are a further 4 configurable touch keys that perform different functions – e.g. intercom, additional door lock activation and generic activations. The video indoor unit has a side lever to adjust: colour, brightness and display contrast, audio and call tone volume. There is a call exclusion notification LED. The installation can be made to the wall using the bracket (supplied) or using table support accessories (2 x 344692) – to be purchased separately. The device also has Professional Studio (Office) function and must be configured.

Item 344652 **CLASSE 100V16B VIDEO INDOOR UNIT**
 2 WIRES handsfree video indoor unit with 5" colour LCD display. The device has 2 physical keys for the control of the main video door entry functions – answer and end a call – and 3 touch keys that allow the door lock release, the entrance panel activation/scrolling and the customisation of a most frequently used quick action – e.g. staircase light control, intercom, additional door lock activation, generic activations. The device has a side lever to adjust: colour, brightness and display contrast, audio and call tone volume. There is a call exclusion notification LED. The installation can be made to the wall using the bracket (supplied) or using table support accessories (2 x 344692) – to be purchased separately. The device must be configured.

Item 344625 **CLASSE 100V16M VIDEO INDOOR UNIT**
 2 WIRES video indoor unit with handset and 4.3" colour LCD display, suitable for wall mounting installation (bracket support included). The device has three touch keys that allows: door lock release, entrance panel camera activation/scrolling and customisation of an auxiliary function – e.g. additional door lock activation and additional camera activation. Side easily accessible and independent regulations for: call volume / ringtone exclusion (with notification LED), display colour and brightness. The handset has magnets for easy holding.

Item 344282 **CLASSE 100A16E HANDSFREE AUDIO INDOOR UNIT**
 2 WIRES handsfree audio indoor unit for wall mounted or table installation. It has 2 physical keys for the control of the main functions – answer and end a call – and has 3 touch keys for the control of the main functions – door lock release, staircase light control and entrance panel activation/scrolling – there are a further 4 configurable touch keys that perform different functions – e.g. intercom, additional door lock activation and generic activations. The device has a side lever to adjust the audio volume and call tone and a call exclusion notification LED. The installation can be made to the wall using the bracket (supplied) or using table support accessory (1 x 344692) – to be purchased separately. The device also has Professional Studio (Office) function and must be configured.

Item 344292 **CLASSE 100A16M AUDIO INDOOR UNIT WITH HANDSET**
 2 WIRES audio indoor unit with handset for wall mounted or table installation. It has 3 touch keys for the control of the main functions – door lock release, staircase light control and entrance panel activation/scrolling – there are a further 4 configurable touch keys that perform different functions – e.g. intercom, additional door lock activation and generic activations. Ringtone volume adjustment (with call exclusion) using the appropriate selector. The installation can be made to the wall using the bracket (supplied) or using table support accessory (1 x 344692) – to be purchased separately. The device also has Professional Studio (Office) function and must be configured.

Item 344692 **ACCESSORIES - TABLE SUPPORT - CABLE - SOCKETS**
 Table support accessory for CLASSE 100 audio and video hands-free indoor units.

Item 346020 **2 DIN ADDITIONAL POWER SUPPLY**
 Additional 2 DIN power supply to be used for the local power supply to connected CLASSE 100x16E (344682) video indoor units in multi-family systems in complexes with more than 22 apartments.

CLASSE 100

Video KIT



Door Entry
CLASSE 100X App

364614

Item 364614 CLASSE 100X16E - LINEA 3000 CONNECTED VIDEO KIT

One-family handsfree kit with: CLASSE 100X16E Wi-Fi connected video indoor unit, handsfree function, inductive loop, 5" LCD display; LINEA 3000 pushbutton panel with zamak front cover, wide angle colour camera, proximity reader and with a set of coloured key cards and two clear discs for door lock release. Can be configured for one-family and two-family installations. It can manage a maximum of 20 key cards (125 KHz) for the electric door lock release (including the one for the system management). Nameplate lit by white LED. Can be wall or flush installed with specific accessories: (350020) flush mounted box and (343061) flush mounted accessory - to be purchased separately. Can be fitted with rainshield (343051)- to be purchased separately. The pushbutton panel has a protection index IP54- protection index against mechanical impact IK10. The video indoor unit has inductive loop function (to enable use by people wearing hearing aids fitted with T selector). It has 2 physical keys for the control of the main functions – answer and end a call – and has 3 touch keys for the control of the main functions – door lock release, staircase light control and entrance panel activation/scrolling – there are a further 4 configurable touch keys that perform different functions – e.g. intercom, additional door lock activation and generic activations. It has a side lever to adjust: colour, brightness and display contrast, audio volume, call tone volume and Wi-Fi configuration. There are call exclusion notification LEDs and Wi-Fi. Also, thanks to the Wi-Fi connection, you can associate the video indoor unit to the Door Entry App (available for Android and iOS). You can manage the main video indoor unit functions (receiving calls, opening the door lock, activating the entrance panel/scrolling, firmware updating and additional activations) from the App. The installation can be made to the wall using the bracket supplied or using table support accessories (2 x 344692) – to be purchased separately. The device also has Professional Studio (Office) function and must be configured.

Dimensional data

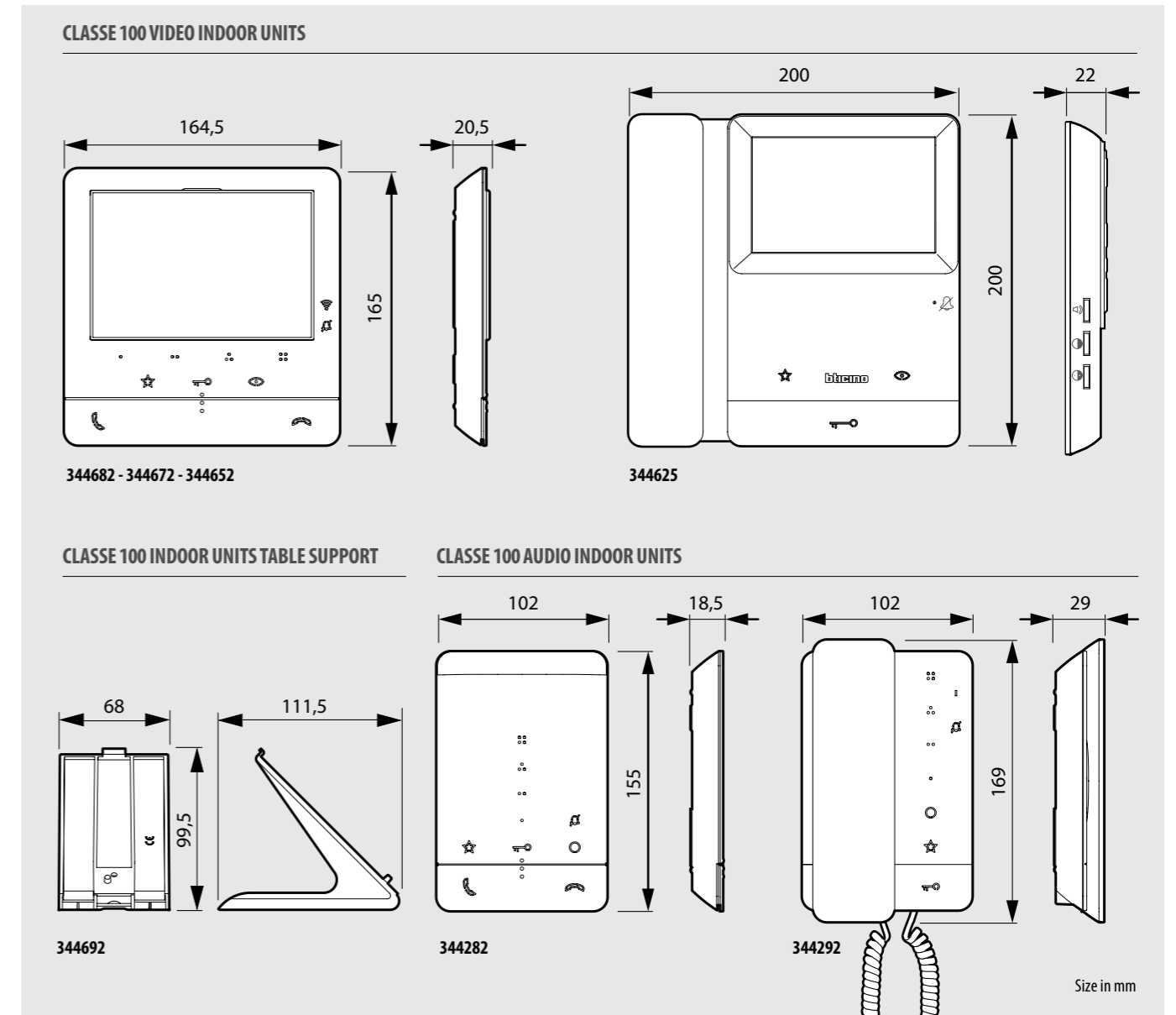

CLASSE 100X16E

Legal notes

To use the video door entry call repeat service on a smartphone, the customer must acquire the technical equipment which allows access to the Internet, on the basis of an agreement made by the customer himself with an ISP (Internet Service Provider). BTicino plays no part in this. The customer must install the Door Entry CLASSE 100X App on his smartphone so that he can use some services which BTicino supplies as extras to the normal basic functions of the CLASSE 100X16E video indoor unit. The services offered by means of the App require being able to interact with CLASSE 100X16E remotely and through the Internet.

In these cases the integration and good working between CLASSE 100X16E and App may depend on:

- a) quality of the Wi-Fi signal;
- b) type of access contract to the home internet;
- c) type of data contract on the smartphone

When one of these 3 elements does not conform with the specifications required for product operation, BTicino accepts no responsibility for any faults. The product supports a VoIP streaming system. You must therefore check with your smartphone contract – data network – that it does not block it. We should also like to inform you that the service provided by BTicino – remote use via App – involves the use of data. The cost linked to data usage depends on the type of contract which the customer has with his ISP (Internet Service Provider) and is solely the customer's responsibility.



Legrand Australia

Building 4 Nexus Industry Park
43-47 Lyn Pde Prestons NSW 2170
1300 369 777
www.legrand.com.au

Legrand New Zealand

106-124 Target Road Glenfield
Auckland 0627 New Zealand
0800 476 009
www.legrand.co.nz